



IMKW6-10, IMKW6-20

Wireless door/ window contact

for Sintony 60 (IC60) SiWay Protocol

- **Very small dimension**
- **Low power design for long battery lifetime**
- **Unique ID code with signal transmission for secure identification**
- **Range up to 300m at free space**
- **External contacts connectable through wired input**
- **Can be used as a input module**

Versatile in application. The ergonomic and discrete design, which fits to every environment, as well as the additional wired input for external contacts, proves the sensor to be ideal for the design sensitive residential sector.

Fast and easy to install. The small dimensions allow easy installation even in space sensible areas around entrance doors and Windows.

Universal use. Through the external wired input all sorts of devices could be integrated into the Security System. If this will be alarm signals as from your heating system, fridge temperature control, Oil tank low, water flood, gas detector etc. This open contact allows you to include already existing devices with almost no additional work in the monitoring function of your Security System.

Coverage area and dimensions

INSTALLATION

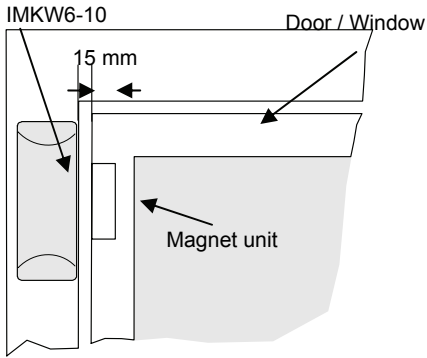

FIG. 2 - KNOCKOUT HOLES

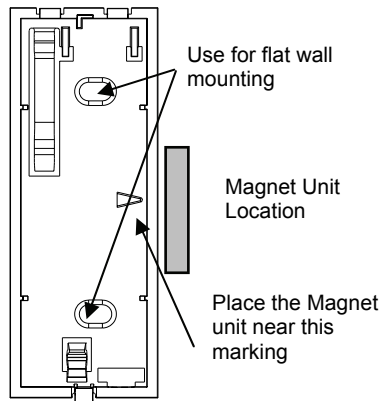
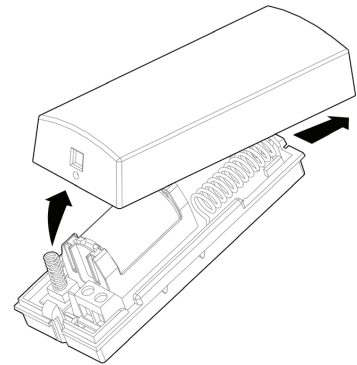

FIG. 1 - REMOVAL OF FRONT COVER



Dimensions: 87mmx35mmx25mm

Technical data

Wireless module – Range / Frequency	up to 300 m at open space/ 868MHz, 915MHz
Identification	Unique ID serial number-24 bit
Event Transmission	Alarm, Tamper, Supervision, Low Bat (30 Days in advance)
Data Protocol	SiWay- Sintony 60
Tamper switch	on front cover removal
Environmental conditions	
– Operation temperature	-10 ... +50 °C
– Storage temperature	-20 ... +60 °C
– Humidity (EN60721)	<85 % r.h., non-condensing
– Housing protection EN60529, EN50102	IP41 / IK02
EMI rejection up to 2 GHz	> 10 V/m
Battery	Lithium 3,6V Size: 1/2AA
Complies with: CE (R&TTE 1999/5/EG), EN50131-1, EN 50131-5-3, TS50131-2-6, Security Grade 2, Environmental Class II, TO14A:2006	

Ordering data

Type	Art. no	Designation	Weight
IMKW6-10	A5Q00013961	Wireless magnet contact 868 MHz	0.040 kg
IMKW6-20	A5Q00013962	Wireless magnet contact 915 MHz (US)	0.040 kg
		Lithium 3,6V Type: XL-050F Size: 1/2AA	0.020 kg

Siemens Switzerland Ltd
International Headquarters
Gubelstrasse 22
CH – 6301 Zug
Tel. +41 41 724 24 24
Fax +41 41 724 35 22
www.sbt.siemens.com

© 2006 Copyright by
Siemens Building Technologies AG
Data and design subject to change without notice. Supply subject to
availability.